

**Model One  
Series**

 **DIPLOMAT  
DENTAL  
SOLUTIONS**

**The right choice.**

## Endless possibilities.

Don't even let us get started on the dozens of options you can choose from. You can customize every little detail of the dental unit to completely satisfy your needs.

## Timeless design.

The basis of the design and materials used in the Model One comes from our premium Model Pro line. The design follows proven principles of ergonomics. Enjoy the essential version to comfortably perform your basic daily activities.

## Reliable partner.

Model One is built with similar and simpler mechanics and electronics than our premium line Model Pro. It is made from premium materials.

Its manufacturing technology has been standardized with our premium line and has already been tested and proven reliable long before product release. Each dental unit is thoroughly tested before it is sent to customers.

# The right choice.

Looking for the right dental unit that brings outstanding performance and provides exceptional comfort for your patient at a competitive price? Model One might just be it.



Model One 100.



Model One 200.



Model One 100 Ortho.



# Model One 100.

Carried version

# Model One 100.

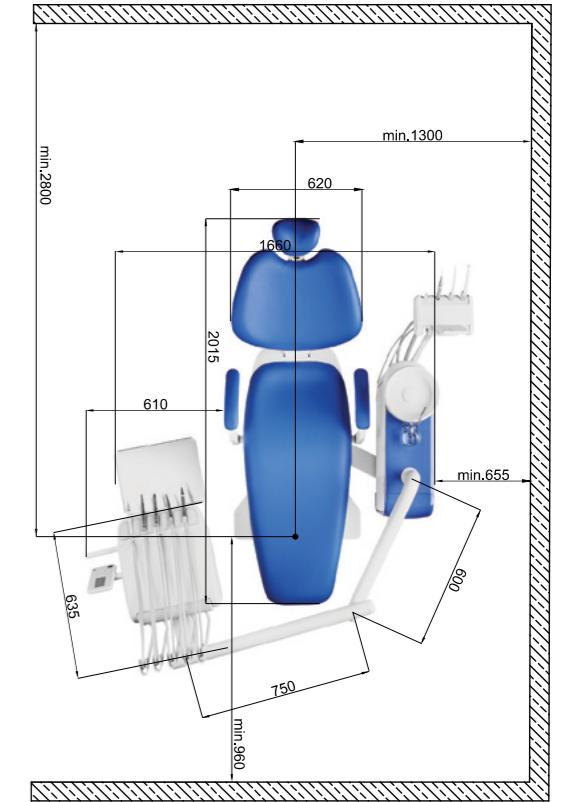
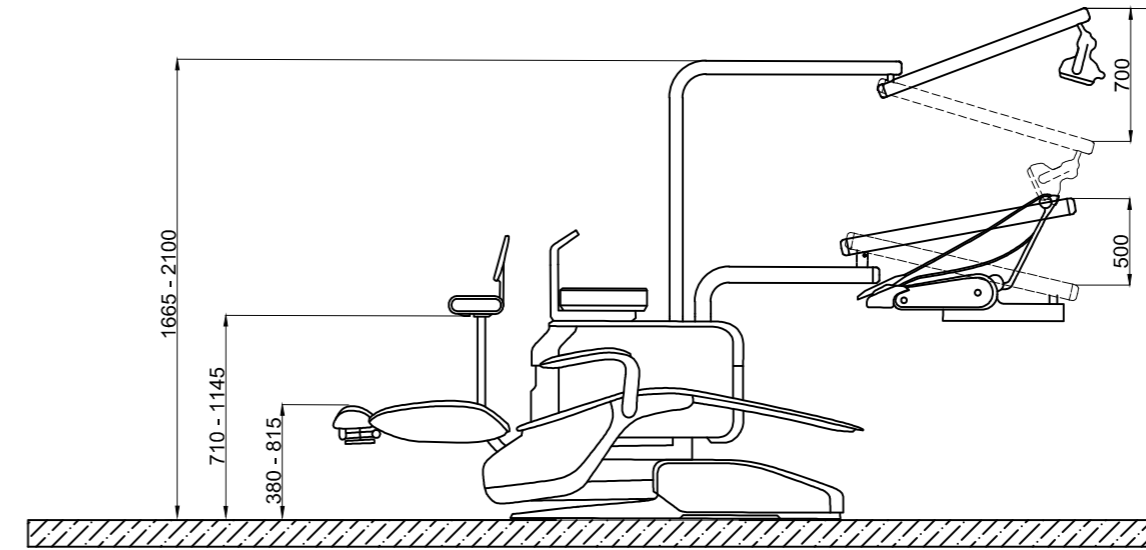

The dental unit with spittoon block and patient chair with synchronized movement. They allow the patient to maintain an optimal distance with the cuspidor bowl during rinsing phases, regardless of the patient's height.

Both models are equipped with a robust chair handling mechanism capable of lifting up to 200 kg, making them an excellent choice for practices with a high volume of patients.



# Model One 200.

Lift version

# Model One 200.

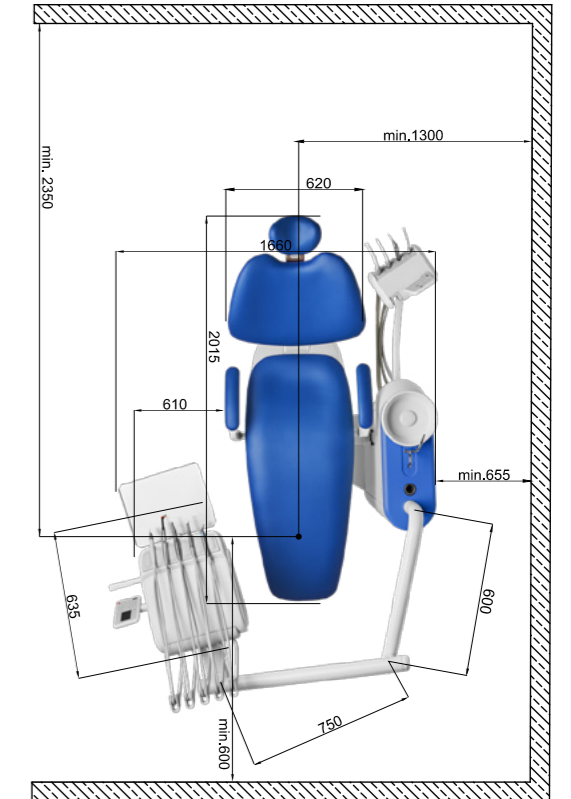
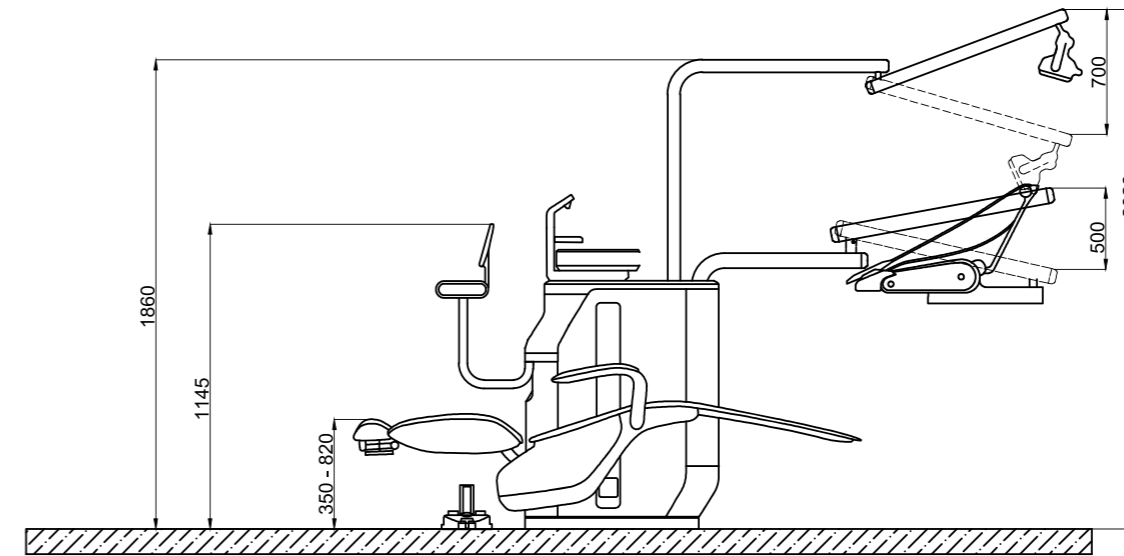

The dental unit with a suspended patient chair and a floor-mounted water unit. It is perfect for practices with limited space due to its compact design. The chair can be lowered significantly to allow easy entry and exit for all patients (the chair can be lowered up to 350 mm from the floor).

Both models are equipped with a robust chair handling mechanism capable of lifting up to 200 kg, making them an excellent choice for practices with a high volume of patients.



# Model One 100 Ortho.

Carried version

## Model One 100 Ortho.

Designed for orthodontists.  
Engineered for precision.

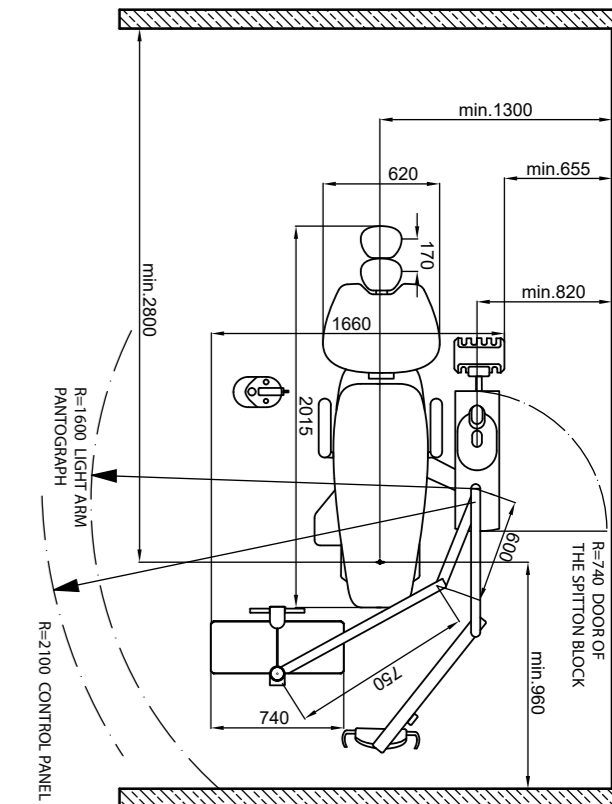
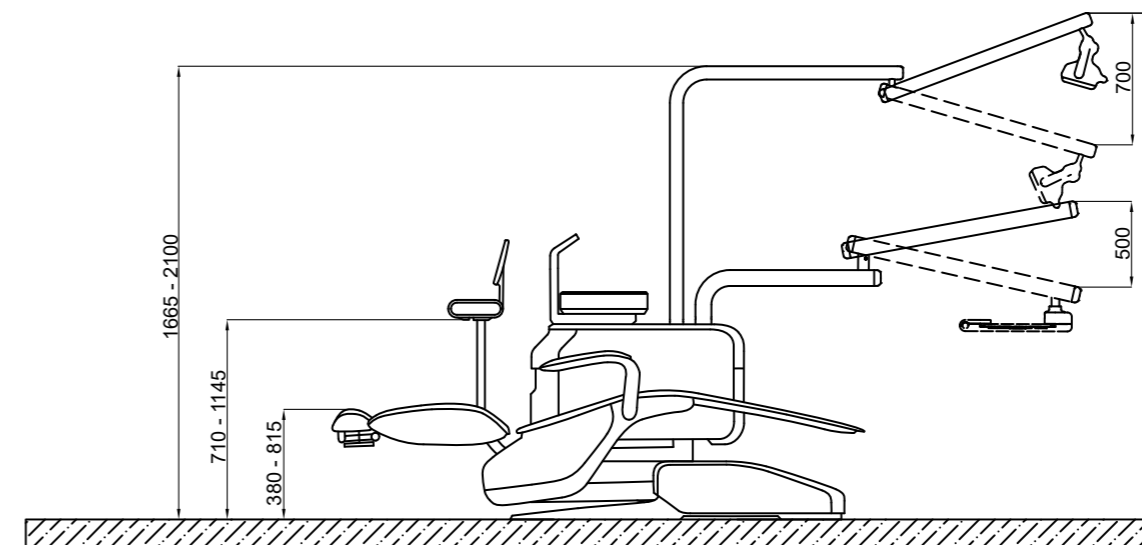

Orthodontists deserve a solution tailored to their needs – Diplomat Dental delivers. The Model One 100 Ortho is designed exclusively for orthodontic professionals. Optimized for orthodontic workflows, it eliminates unnecessary features and focuses on what truly matters: efficiency, comfort, and seamless patient care.

- **A dental chair made exclusively for orthodontic professionals.**
- **Optimized for your workflow – no unnecessary features.**
- **Efficiency, comfort, and seamless patient care.**
- **Timeless design.**

# Endless possibilities.

Close your eyes and imagine the dream dental unit. Now open them, and make it happen with Model One. With almost endless customization options, the way your Model One looks and works is just up to you.

## Up or down?

Enhance your dentist's element with an upper or lower hose delivery system.

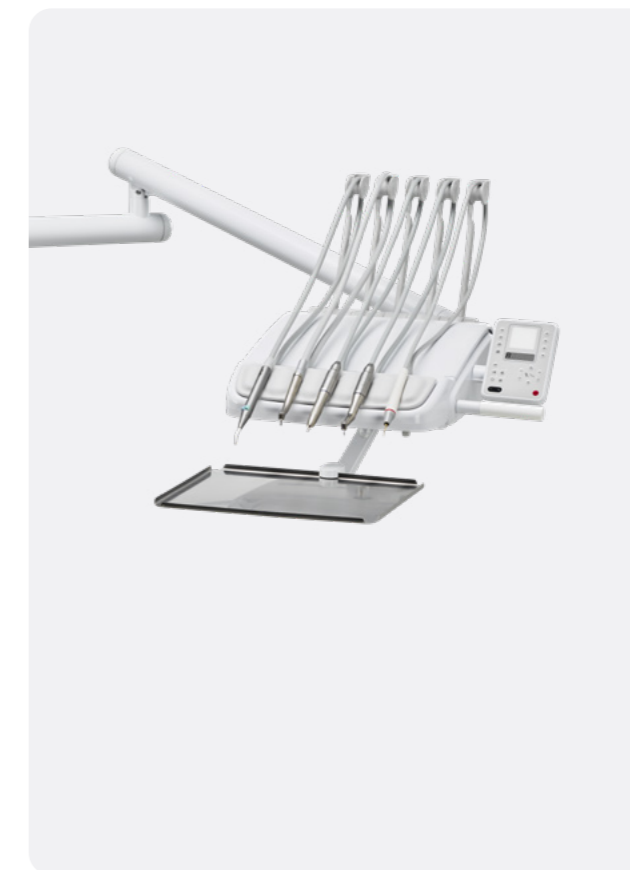

## Hold the whip hand.

The dentist's element with instrument hoses routed in the upper hoses configuration may be equipped with a whip lock. An instrument whip is routed to the instrument placed in a designated slot. The whip is pulled towards the stop to unlock. The whip then returns to its resting position.

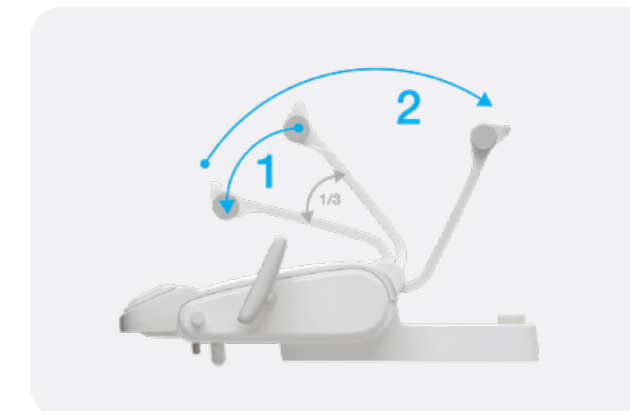
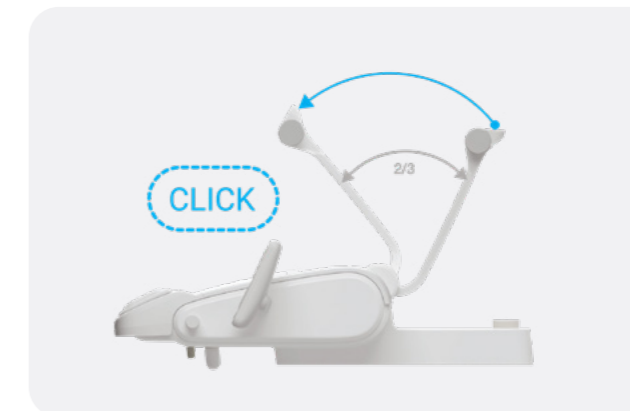

## Put your skills on display.

The control panel on the dentist's element comes in two variants. The button layout of both options include controls for four custom chair positions and the getting-on position. You can also pre-program two unique dentist profiles for both of the variants.



### Control panel One.

The standard control panel comes with a 5-digit display unit which provides you with information regarding the RPM of the currently used micromotor. This version of the control panel includes buttons for the chair, light, cup and cuspidor control. It also rocks a fancy negatoscope!

1 Buttons for light, cup, cuspidor.

2 Buttons for chair control.

3 Buttons for instrument settings.\*



### Control panel One Plus.

The advanced control panel comes with a full-color display and extra buttons to control the endodontics functions of your instruments. This choice also supports automatic hygiene.

## Intuitive instrument control.

The instruments on the dentist's element are activated once removed from the individual holsters.

## One button to rule them all.

The instrument settings can be customized with four different presets.



### Multi-colored LED indicators on Control panel One.

To support a dentist's workflow while using Control Panel One we use intuitive multi-colored LED indicators to recognize switching functionalities.

	LIGHT OFF	WHITE LIGHT	GREEN LIGHT	BLUE LIGHT
	Cooling down	Spray cooling	Water cooling	Air cooling

## Pick your scaler.

The selection of scalers compatible with Model One's Control panel One Plus includes:

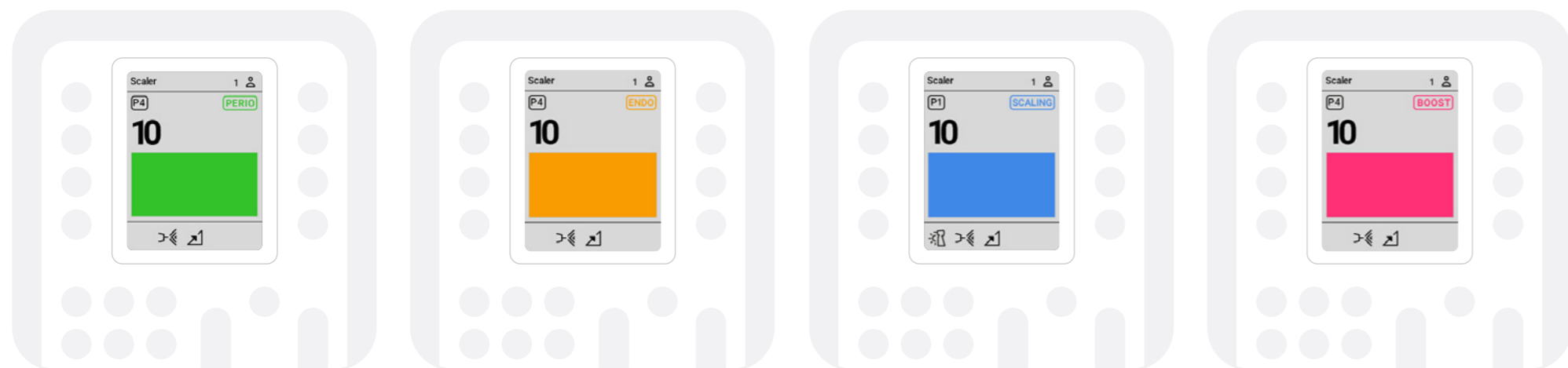

PERIO

ENDO

SCALING

BOOST

Scaler	PERIO	ENDO	SCALING & GENERAL	BOOST
Satelec SP Xinetic	•	•	•	
Satelec NEWTRON	•	•	•	•
Satelec NEWTRON LED	•	•	•	•
NSK VA170	•	•	•	
NSK VA170 LED	•	•	•	
WOODPECKER		•	•	

EMS The EMS scalers do not have specific functions. Their intensity range is from 0-10, which covers all modes.



# Endodontic functions.

Control Panel One Plus with micromotor DX Pro or DX Pro Blue enables you to use additional endodontic functions. This includes auto-reverse and auto-forward features.

It's possible to adjust the speed range from 100 to 40,000 RPM and the torque is adjustable to 3.5Ncm.

## And yet it moves!

The standard version of the Model One's cuspidor is fixed to the cuspidor. However if you want to provide your patients with additional comfort, you can choose the rotary option.



## What light will you turn on?

You can choose from XENOS, MAIA or SIRIUS dental lamps. The XENOS lamps reaches up to 26.000 Lux. The MAIA offers up to 45.000 ±10% Lux with a CRI > 95. SIRIUS delivers even higher performance depending on the configuration below. All lamps have hands-free operation functions thanks to the no-touch sensor.

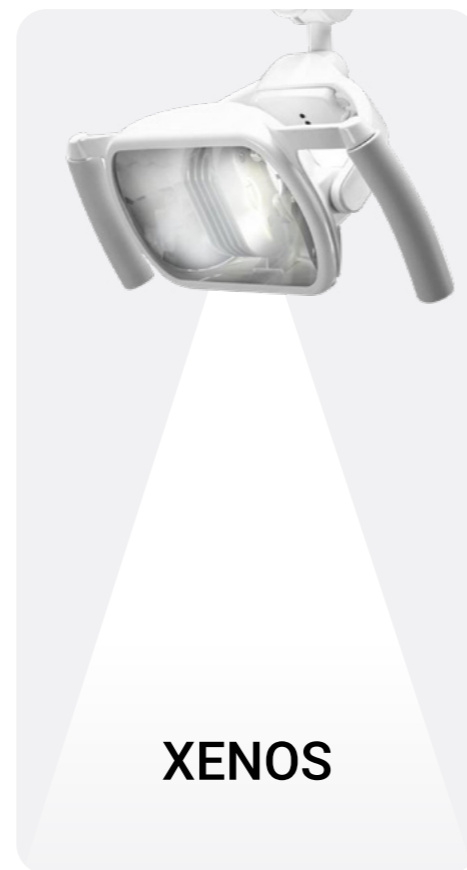

## SIRIUS



### Available in options:

#### SIRIUS Essential

- 4 x LED white
- 35 000 Lux
- LED temperature 5500 K
- No composite mode
- Sharp illumination area
- Smooth adjustment of illumination intensity across the full min/max range

#### SIRIUS Plus

- 4 x LED white, 4x LED yellow
- 35 000 Lux
- LED temperature 5500 K
- Composite mode ("Yellow" – light with filtered blue light wavelength 430–480 nm)
- Sharp illumination area
- Smooth adjustment of illumination intensity across the full min/max range

#### SIRIUS Power

- 4 x LED white, 4x LED yellow
- 50 000 Lux
- LED temperature 5500 K
- Composite mode ("Yellow" – light with filtered blue light wavelength 430–480 nm)
- Sharp illumination area
- Smooth adjustment of illumination intensity across the full min/max range
- Four steps adjustment of illumination intensity across the full min/max range (at LED temperature 4000–4800 K)

## Pedal to the metal.

Even though you might not feel the same adrenaline as in a racing car, you get ergonomic and practical benefits from using foot controllers. You can select from three options compatible with Model One.



### MARQUARDT

Stable and skid-proof thermoplastic housing with rubber feet.



### NOK

Vertically operated multifunction foot pedal to control instruments, chair and water unit.



### SWING

Horizontally operated multifunction foot pedal for controlling instruments, chair, and water unit. With Improved ergonomics and easy control of the instruments' spray with the lever.

## Ready for an extra pair of hands.

The assistant's element has six instrument holders. Two versions are available: BASIC and ADVANCED. The BASIC assistant element allows the assistant to control cuspidor rinsing and cup refilling. With the ADVANCED assistant's element, you will also be able to control the chair's movements, including the Trendelenburg position.

Basic

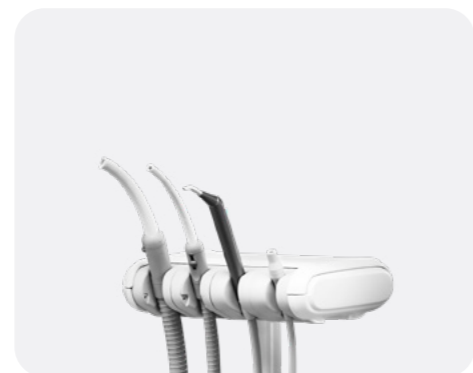

Advanced



# Model One 100 Ortho.

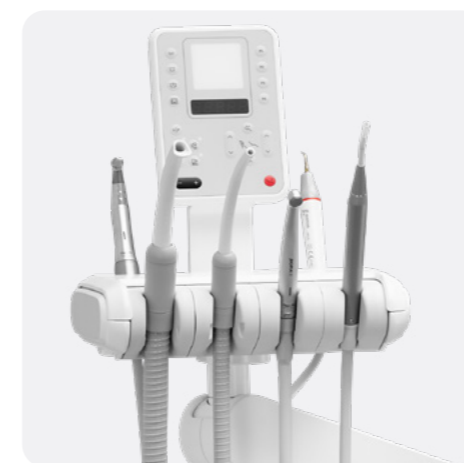

## Possible configurations.

Pantographic Assistant Arm  
(as Model Pro)

Control Panel One

Suction hoses

Syringes

Turbine (max 1)

Micromotor (max 1)

Scaler

Polymerization light

Intraoral Camera



See more option at page 40.



## Fast, faster, Model One.

Model One has simple manual hygiene in the standard version, but you can upgrade to fully automatic hygiene. Model One maintenance is fast and easy, regardless of your choice.

## Even manual disinfection is an easy chore.

If you choose the standard version of Model One, which is not equipped with an automatic water channel and suction hose hygiene system, regular manual hygiene is still possible. All of the systems are very easily maintained and come with simple and clear recommendations.

## Automatic disinfection of instrument water channels.

The recommended disinfectants are Alpron, Sanosil S003, or Dentosept P in a 1% concentration with distilled water. These products in a 1% concentration are completely inert with respect to patients.



## Hygiene holder.

## Intensive disinfection of instrument water channels.

The recommended disinfectants are Alpron, Sanosil S003, or Dentosept P in a 100% concentration. The cooling system channels are kept clean and there is no need to use other means of disinfection.



## Instrument hoses in hygiene holder.

## Automatic hygiene has 4 settings options:



## Automatic hygiene of big and small suction hoses.

- |  |   |
|--|---|
| <p><b>1.</b><br/>Beginning of a workday hygiene.</p> | <p><b>2.</b><br/>After treatment hygiene.</p> |
| <p><b>3.</b><br/>End of a workday hygiene.</p>       | <p><b>4.</b><br/>Intensive hygiene.</p>       |

# Timeless design.

We shaped the award-winning design of our Model Pro Series and used it to create the Model One fundamental design, to support the dentist in their essential needs. The same materials, body parts, and ergonomically oriented design philosophy.

## Business class tickets, please.

Next time your patients visit you, let them know they may as well imagine they're sitting in a limo. Why? We've teamed up with ergonomics experts from the dental industry to design this absolute masterpiece of a dental chair to reduce your patient's physical strain and make them as comfy as possible.



## Simple is an understatement.

The control panels use a clear and simple button layout, graphics, and a high-quality surface finish. We've kept it simple, so you can completely focus on your job without any distractions or mistakes.



## Hard to get your eyes off of it.

Clean geometry, well-designed user interface, compact size, and great ergonomics. All of these combine to make Model One not just a sight to see, but, also a great product to use.



## Pleasant to the touch.

Most of the materials used, such as UV-resistant and chemically resistant ASA plastic or galvanized semi-matte metals, can match even the most premium products on the market.



# Love at first seat.

The base of Model One's design, ergonomics and materials used come from our premium model line Model Pro.

- a) The backrest is wide enough to ensure patients' upper body side movement.
- b) For the most demanding dentist, a 3D headrest is essential to allow a lateral flexion position of the patient head.

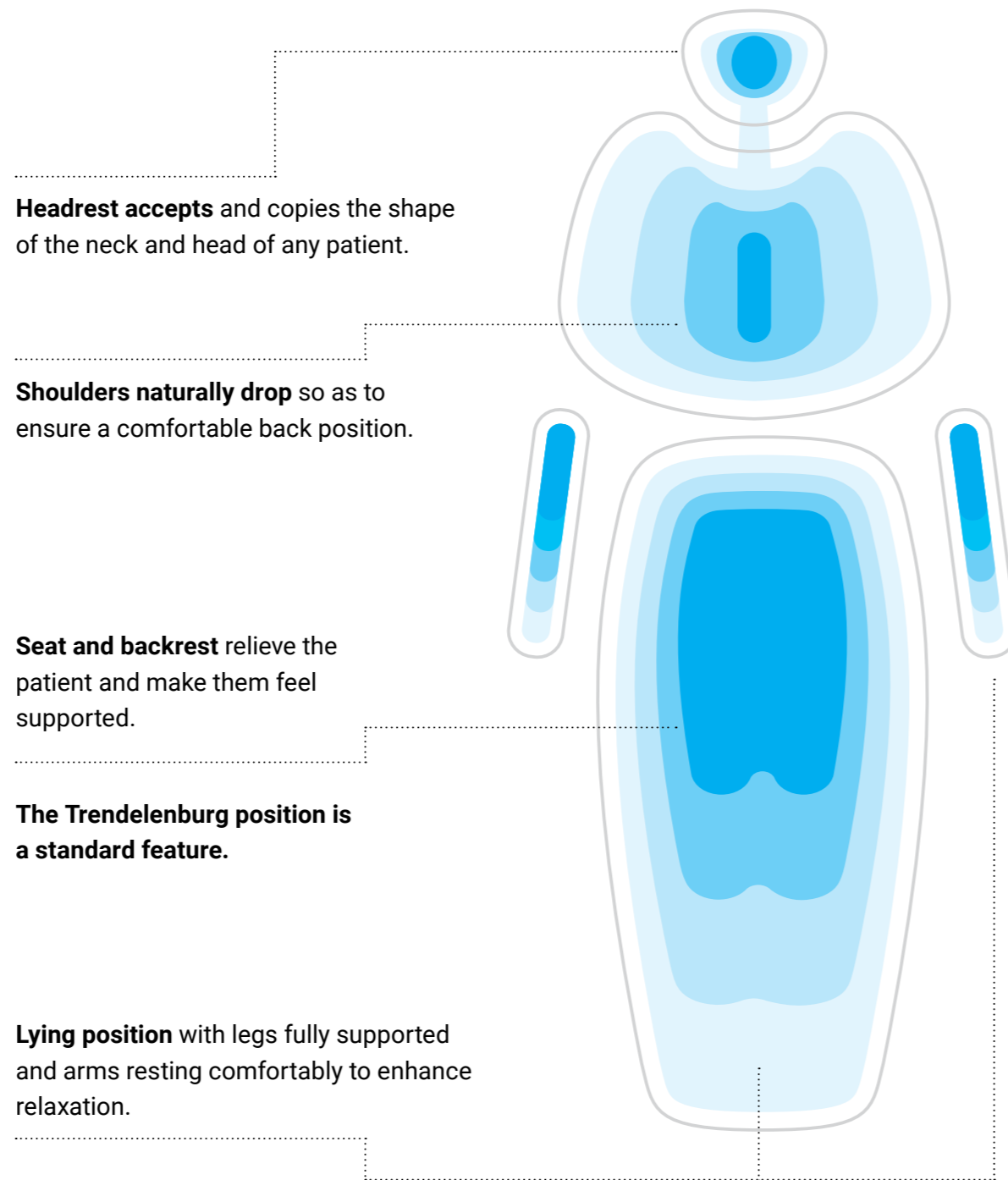

## Model One takes care of you.

It's not just your patients but you that deserve the best. Musculoskeletal problems appear to be the leading cause of dental practitioners' premature retirement from practice.

Great ergonomics are essential for your long-term health. Model One meets all the conditions for ergonomic work, from palatine treatment to operational positions.

## Some of the ergonomic highlights:

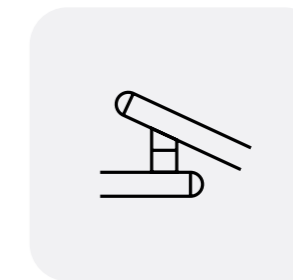

The dental unit's arms are ergonomically adapted for your daily work.



Wide backrest for greater patient mobility and better dentist ergonomics.



Minimum backrest thickness to allow dentists to get close to the patient's head.



The dentist's and assistant's elements can get incredibly close for a two-handed treatment at the 12 o'clock position.

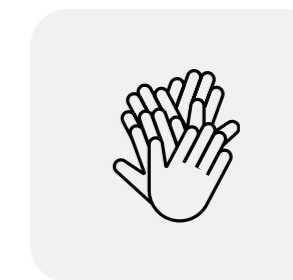

The assistant's element can free the space for four-handed treatment.

# Feeling frisky?

Whatever you feel like, we're giving you the freedom to express yourself. With the choice of dozens of color and upholstery options, it's just about your preference. Take a look at the most popular choices. You'll find all available options in our [upholstery catalogue](#).

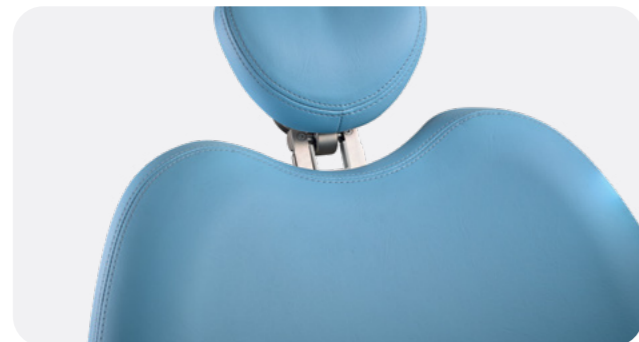

## Standard Upholstery.

No stitches, easy to clean, rubbing resistance, resistance to disinfectants and washability. With easy fix adjustment without screws.

## Comfort Upholstery.

More comfort, with stitches for elegant design, rubbing resistance, resistance disinfectants and washability. With easy fix adjustment without screws.

## Premium Upholstery.

Extra comfort, active foam, with stitches for elegant design, rubbing resistance, resistance disinfectants and washability. With easy fix adjustment without screws.

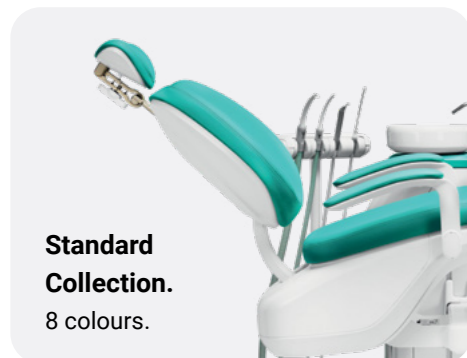

**Standard Collection.**  
8 colours.

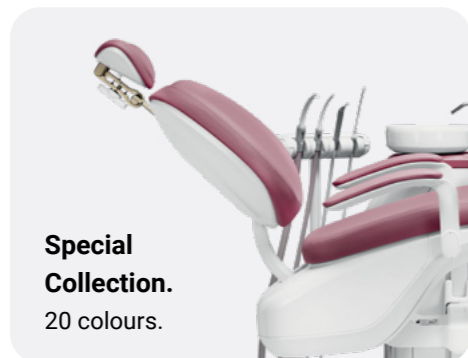

**Special Collection.**  
20 colours.

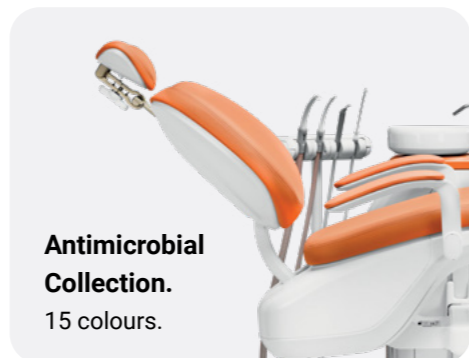

**Antimicrobial Collection.**  
15 colours.

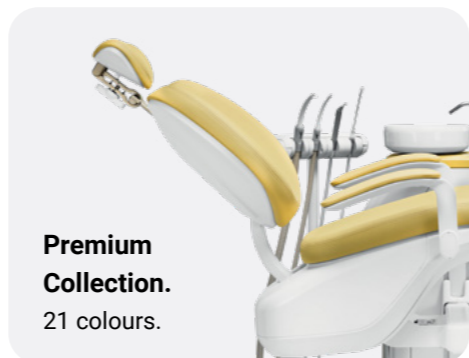

**Premium Collection.**  
21 colours.

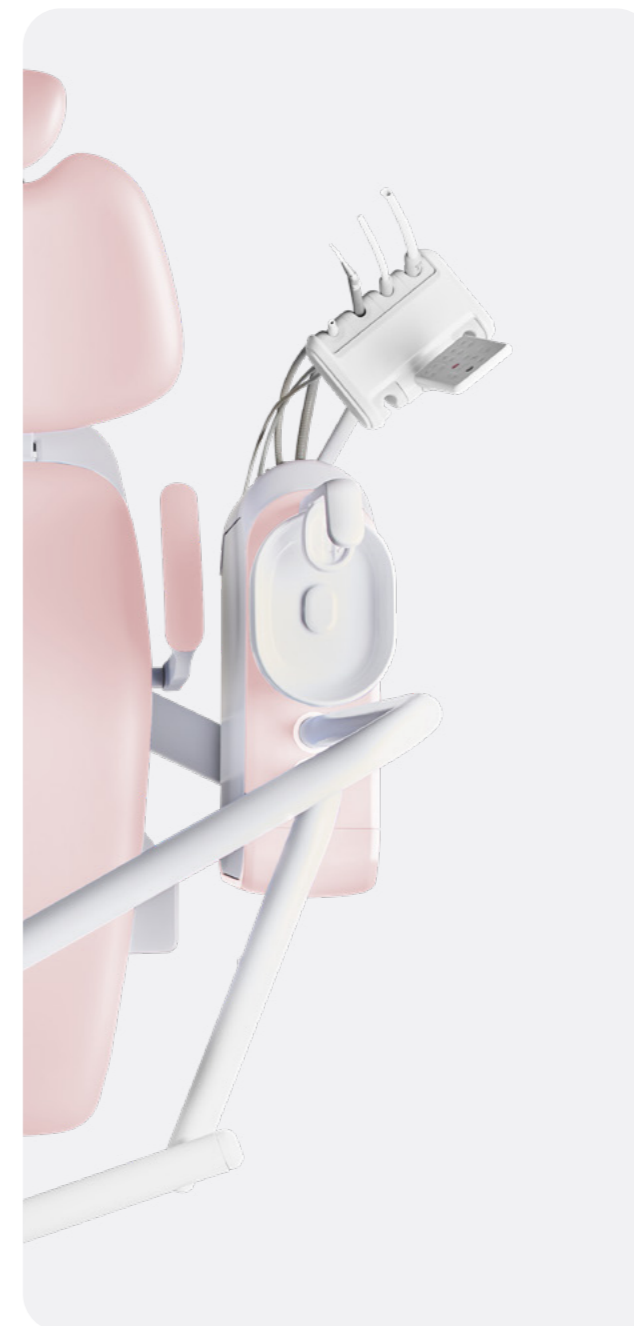
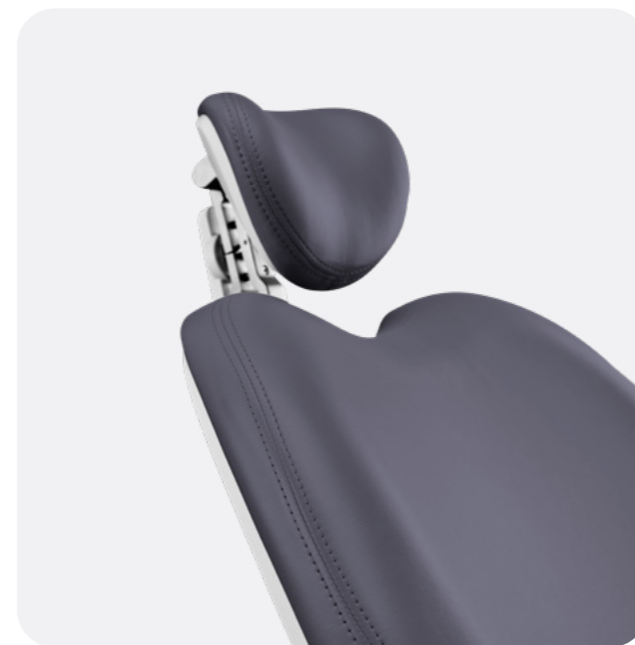

**Choose custom color for upholstery and plastic cover.**

# Express your style.



Choose from new color options and match your upholstery with other parts of the dental unit.

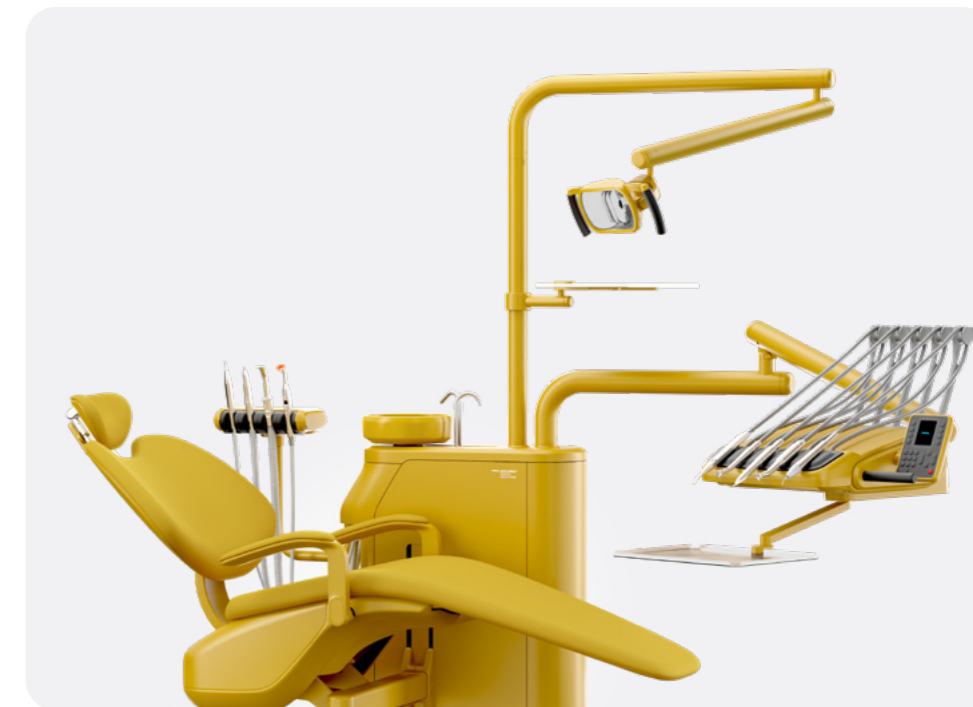
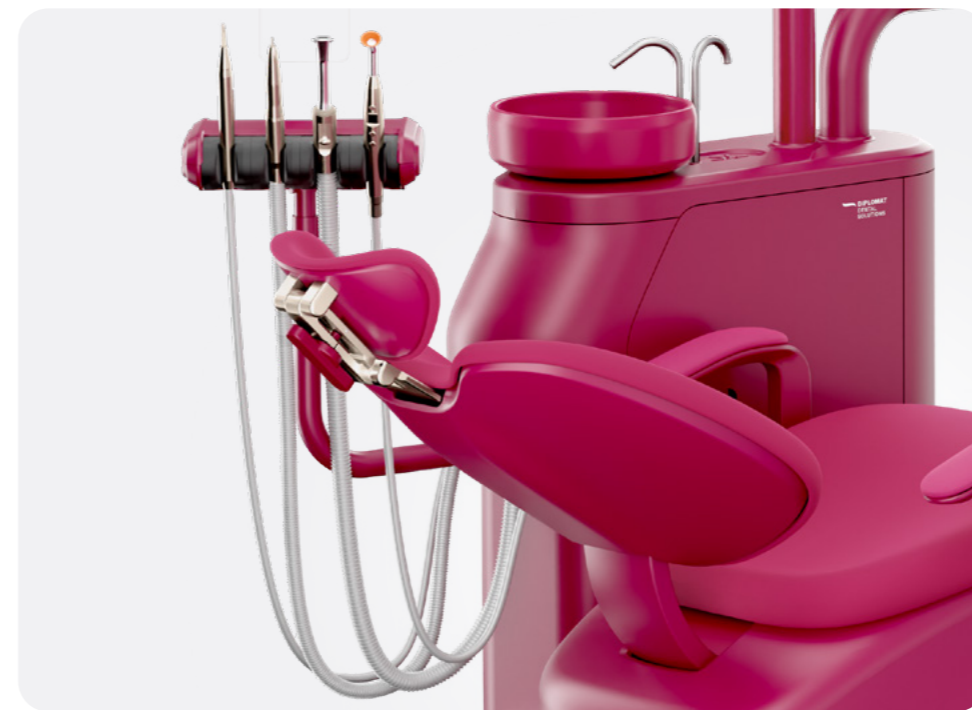

The full painted units photos presented are demonstrative. Some of the elements of the unit, such as foils (control panel, assistant element), instrument holders, whip arms, rubber covers, must remain in original colors, cannot be painted. Ask your dealer for details.

# Reliable partner.

Ease of use and essential functions are the main philosophy behind Model One. Even on your first day with Model One, it will feel like you've worked with it for ages.

## In your natural habitat.

Model One provides comfortable access to all your tools, instruments and control panels at all times.

## Comfortable for all shapes and sizes.

The range of the chair lift is extremely large – from 35 cm to 82 cm. Thanks to this, your child patients will easily be able to hop onto the chair. It also provides a comfortable workspace for dentists of smaller or even larger stature.

## Installation? Eaaaasyyyyy.

The installation of Model One is very easy and swift, and you can start working almost as soon as it's delivered to you.



# Diplomat Dental by Bien-Air – Swiss precision at your fingertips.

Your handpiece is more than just a tool – it's an extension of your expertise.

That's why **Diplomat Dental handpieces by Bien-Air** are designed to deliver unmatched precision, durability, and comfort for every procedure.



## Uncompromising quality.

Swiss-made excellence ensures smooth operation, perfect balance, and long-lasting performance.

## Exceptional reliability.

Built to withstand intensive daily use while maintaining consistent power and minimal vibrations.

## Peace of mind guaranteed.

Enjoy a 2-year warranty, ensuring long-term reliability and confidence in every procedure.

## Global technical support.

Wherever you are, expert service is always within reach.

## Seamless integration.

Elevate your Diplomat Dental unit with high-end Swiss instruments for a superior clinical experience.



## Pro line.

- Diplomat CA NOVA 1:5L
- Diplomat CA NOVA 1:1L
- Diplomat TORNADO LED/LK

## Classic line.

- Diplomat CA 1:5L
- Diplomat CA 1:1L
- Diplomat BORA 2 LED/LK
- CA 20:1L Micro series
- PM 1:1 Micro series

Precision, durability, and performance – because great dentistry starts with great instruments.

# IRIS – the new generation of dental stools.

IRIS is a modern line of dental stools created to focus on what truly matters: ergonomics, durability, and timeless design. Developed for dentists and assistants, IRIS enables comfortable, healthy, and efficient seated treatment – from routine hygiene procedures to restorative and preventive care.

Carefully selected materials, precision engineering, and compliance with international standards (EN ISO 7493) make IRIS a reliable choice for any dental practice. Its clean, contemporary design fits seamlessly into any treatment room, ensuring visual harmony and professional appearance.



## Key benefits.

**Ergonomics.** Promotes healthy posture, reduces strain, and supports dentists during long working hours.

**Durability.** Built to last, even under intensive daily use.

**Design.** Timeless, versatile, and perfectly integrated into any dental workspace.

## Versions.

**IRIS with Classic Backrest.** Height adjustable with pneumatic piston:

- Minimum seat height: 490 mm.
- Maximum seat height: 650 mm.

**IRIS with Classic Backrest + “Banana” Support Arm.** Same height range as above, with additional lateral support for more demanding procedures.





Designed for posture, built for precision.

Sit smarter. Work longer.



Comfort that moves with you.



### Mechanism options.

**Basic version.** Simple seat height adjustment.

**Advanced Ergo mechanism.** Seat tilt, backrest inclination, and seat height adjustment for fully personalized comfort.

**Silent block seat mounting.** Allows the seat to follow the dentist's movement, improving dynamic ergonomic support.

### Comfort & materials.

**Molded PUR foam seat with ergonomic shaping.** Maximum comfort, durability, and even weight distribution (a major upgrade over traditional cut foam).

**Contoured backrest.** Stable support during precision work.

### Accessories & options.

- Armrest left and right side.
- Special armrests for microscope users.
- Foot ring for additional leg support.
- Wheels with brake system for stable positioning.

# Focus on reliability & high quality.

All our products are carefully designed and engineered to meet the specific needs of our customers while always attaining our high-quality standards.

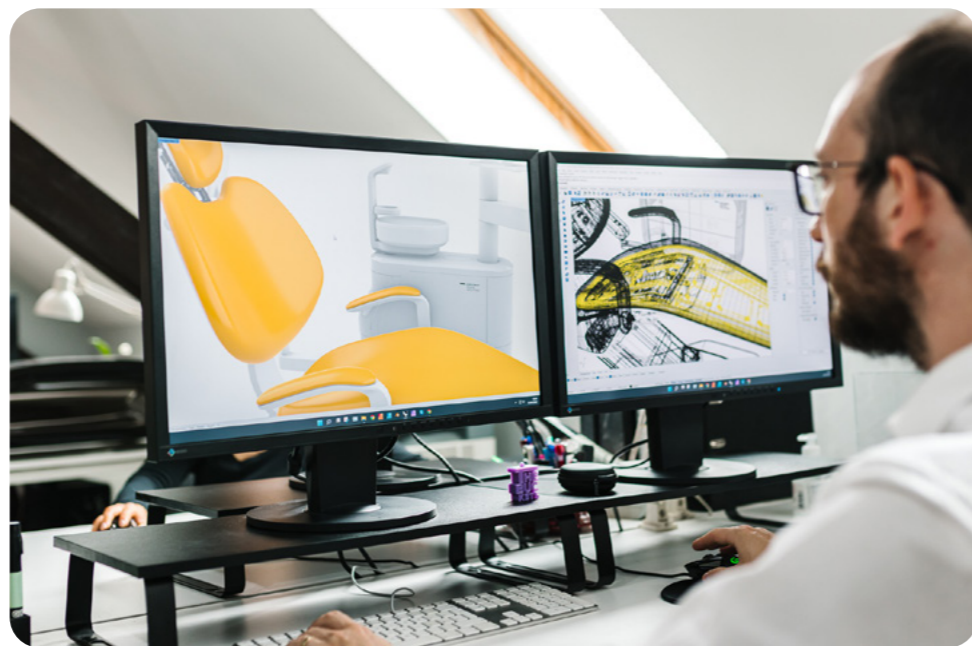

90% of our components are manufactured in-house. Each component of every dental unit is thoroughly checked more than 15 times during the manufacturing process as we process it from the input material to the final element of the dental unit.

One of our biggest strengths lies in our R&D team and our numerous cooperations with experienced partners and industry experts.

Each newly developed product is tested internally for four months



to a year in our internal test room. After this process, our beta tester dentists work with the prototypes for up to one year while we use their feedback to fine-tune the product.



Diplomat Dental products are highly customizable. We can accommodate specific requirements and needs of our customers.



"Our product philosophy is into focus on open platforms, modular and intelligent solutions that improve the workflow of your dental office – making advanced technologies and smart tools easy to use and accessible to every dentist."

Tomas Nerad,  
CEO – Diplomat Dental

# Get the full experience with our accessories.

Take a look at our full range of accessories that are compatible with Model One.

## Dentist element



Standard  
**Traditional style 5 instrument option**



Standard  
**Continental style 5 instrument option**

## Control pannel



Standard  
**One**



Optional  
**One Plus**

## Tray



Optional  
**Aluminum tray**  
sized 380x285 mm



Optional  
for Model One 100 Ortho  
**Single aluminum**  
sized 500x290 mm



Optional  
for Model One 100 Ortho  
**Double aluminum tray**  
sized 2x 370x290 mm

See more option at page 40

## Assistant's element



Standard  
**Saliva ejector with adapter on water unit**



Optional  
**Basic**



Optional  
**Advanced**

## Cuspidor



Standard  
**Fixed cuspidor**



Optional  
**Rotating cuspidor (manual rotation only)**

## Headrest



Standard  
**2D**



Optional  
**3D**

## Monitor



Optional  
**Neovo monitor 22" DR22 white Widescreen**  
**Neovo monitor 22" RX22G black, FULL HD Widescreen**

## Lamp



Standard  
**XENOS**



Optional  
**MAIA**



Optional  
**SIRIUS**

## Footcontroler



Standard  
**Marquardt**



Optional  
**Nok**



Optional  
**Swing**

## Upholstery types



Standard (seamless)  
Upholstery



Comfort (stitched)  
Upholstery

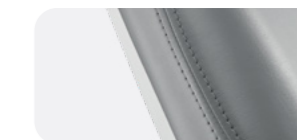

Premium (stitched)  
Upholstery with Active  
foam

## Upholstery colours collections

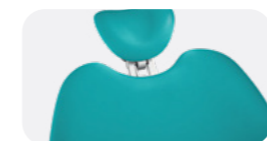

Standard  
collection

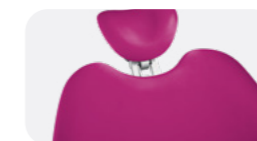

Special  
collection



Antimicrobial  
collection

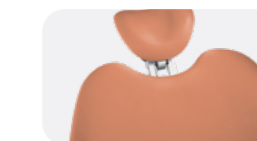

Premium collection  
(only for Premium  
upholstery)

## Water unit



Standard  
**Big and Small suction hoses with manual regulation (one filter)**



Optional  
**Big and Small suction hoses with selection valve (two filters)**

## Stool

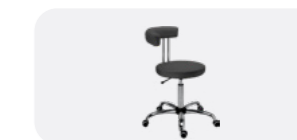

Optional  
**With a backrest for the dentist, With a backrest for the assistant, Horse-seat for a microscope**

## Accessories



Optional  
**Pillow for children**



Optional  
**Protection cushions**

## Paint



Optional  
**Complete paint in semi-matt white**

# Choose your own features.

Model One 100/Model One 100 Ortho	
Plate for non-grounding/floating floor/exhibition	<input type="radio"/>
Synchronized movement of backrest and patient chair	<input type="radio"/>
Headrest 2D	<input type="radio"/>
Headrest 3D	<input type="radio"/>
Left armrest	<input type="radio"/>
Right armrest	<input type="radio"/>
Pillow for children	<input type="radio"/>
Protection cushion	<input type="radio"/>

Dentist's element	
Continental style with 5 instruments	<input type="radio"/>
Traditional style with 5 instruments	<input type="radio"/>

Tray	
Aluminum tray 380x285 mm	<input type="radio"/>
Optional for Traditional Style (TS) – Left 380x285 mm	<input type="radio"/>
Optional for Traditional Style (TS) – Double 2x 380x285 mm	<input type="radio"/>
Optional for Model One 100 Ortho – Single aluminum 500x290 mm	<input type="radio"/>
Optional for Model One 100 Ortho – Double aluminum 2x 370x290 mm	<input type="radio"/>

Cuspidor	
Fixed cuspidor	<input type="radio"/>
Rotating cuspidor (manual rotation only)	<input type="radio"/>

Color version of dental units	
Color set painting on water unit – possible to choose from all colors	<input type="radio"/>
Complete unit painted in semi matt	<input type="radio"/>
Complete unit painted in customized color	<input type="radio"/>

Configure Model One to become your dream dental unit.

Model One 200	
Plate for non-grounding/floating floor/exhibition	<input type="radio"/>
Synchronized movement of backrest and patient chair	<input type="radio"/>
Headrest 2D	<input type="radio"/>
Headrest 3D	<input type="radio"/>
Left armrest	<input type="radio"/>
Right armrest	<input type="radio"/>
Pillow for children	<input type="radio"/>
Protection cushion	<input type="radio"/>

Control Panel	
Control Panel "One" with negatoscope	<input type="radio"/>
Control Panel "One Plus" <i>*compulsory to run the Endo function and automatic sanitization process</i>	<input type="radio"/>

Upholstery	
Standard – Smooth finish (no stitching)	<input type="radio"/>
Comfort – Enhanced comfort (with stitching)	<input type="radio"/>
Premium – Advanced comfort with active foam and elegant stitching	<input type="radio"/>

*The colors of the leather can be selected in the upholstery catalogue.*

Dentist's element additional options	
Separate water regulators for each instrument	<input type="radio"/>
Whip lock only for CS (upper hose) delivery system	<input type="radio"/>

Instruments for dentist's elements	
<b>SYRINGE</b>	
Minimate 3F syringe	<input type="radio"/>
Minilight 3F syringe	<input type="radio"/>
Minilight 6F syringe	<input type="radio"/>
Minilight 6F syringe straight with light and module	<input type="radio"/>
Miniassistant 3F syringe – INOX (metal), round-shaped	<input type="radio"/>
DCI syringe – INOX (metal)	<input type="radio"/>
<b>MICROMOTOR</b>	
SET DENSIM DX motor with accessories	<input type="radio"/>
SET DENSIM DX PRO motor with accessories	<input type="radio"/>
SET DENSIM DX BLUE motor with accessories	<input type="radio"/>
SET DENSIM DX PRO BLUE motor with accessories, endo functions auto reverse, auto forward	<input type="radio"/>
<b>TURBINE HOSE</b>	
Midwest fibre-optic hose for turbine	<input type="radio"/>
Turbine output regulation (for one or two turbines)	<input type="radio"/>
<b>SCALER</b>	
LM-ProPower UltraLED scaler with light with module (4 tips)	<input type="radio"/>
EMS MiniPiezon FS-433 scaler without light (3 tips)	<input type="radio"/>
EMS MiniPiezon FS-432 LED scaler with light (3 tips)	<input type="radio"/>
EMS MiniPiezon FS-367 LED scaler with light (3 tips)	<input type="radio"/>
Satelec SP Xinetic scaler without light (1 tip)	<input type="radio"/>
Satelec NEWTRON scaler without light (3 tips)	<input type="radio"/>
Satelec NEWTRON LED scaler with light (3 tips)	<input type="radio"/>
NSK VA170 scaler without light with module (3 tips)	<input type="radio"/>
NSK VA170 LED -Lux scaler with light with module (3 tips)	<input type="radio"/>
Woodpecker UDS-N3 LED scaler (6 tips)	<input type="radio"/>
<b>CURING LIGHT</b>	
Mectron Starlight	<input type="radio"/>
Monitex curing light	<input type="radio"/>

Assistant element	
BASIC assistant's element	<input type="radio"/>
ADVANCED assistant's element	<input type="radio"/>
Saliva ejector with adapter on water unit	<input type="radio"/>

Assistant element arm	
Short arm (ideal for 4-hands treatments)	<input type="radio"/>
Long arm (ideal for 2-hands treatments)	<input type="radio"/>
Pantographic Assistant Arm	<input type="radio"/>

Assistant's element instruments	
Minimate 3F syringe	<input type="radio"/>
Minilight 3F syringe	<input type="radio"/>
Mectron Starlight	<input type="radio"/>
Monitex curing light	<input type="radio"/>
Rollers for big and small suction hoses (2 pcs.)	<input type="radio"/>
Diplomat intraoral USB camera with software for connection with PC and accessories	<input type="radio"/>
Additional saliva ejector (not possible to combine with "only saliva ejector" option and with any amalgam separator)	<input type="radio"/>

Foot Control	
SWING foot control (recommended by Diplomat Dental)	<input type="radio"/>
NOK foot control	<input type="radio"/>
Marquart foot control	<input type="radio"/>

Dental lights	
Xenos (up to 26.000 Lux)	<input type="radio"/>
Faro MAIA LED lamp with sensor (up to 40.000 Lux)	<input type="radio"/>
Sirius Essential (35.000 Lux)	<input type="radio"/>
Sirius Plus (35.000 Lux)	<input type="radio"/>
Sirius Power (50.000 Lux)	<input type="radio"/>

Light pole	
Light pole for operating light only	<input type="radio"/>
Light pole for operating light and suitable for extra tray	<input type="radio"/>
Light pole with operating light, suitable for tray plus monitor adapter	<input type="radio"/>

Assistant's elements instrument for Model One 100 Ortho	
<b>SUCTION HOSES</b>	
Big (HVE) and Small suction with manual regulation	<input type="radio"/>
Big (HVE) and Small suction with selection valve	<input type="radio"/>
Saliva Ejector	<input type="radio"/>

SYRINGES	
Miniassistant 3F	<input type="radio"/>
DCI	<input type="radio"/>
Luzzani Minimate	<input type="radio"/>
Luzzani Minilight	<input type="radio"/>

TURBINE (MAX 1)	
Midwest fibre-optic hose for turbine	<input type="radio"/>
Turbine output regulation (for one or two turbines)	<input type="radio"/>

MICROMOTOR (MAX 1)	
Densim DX	<input type="radio"/>
Densim DX Blue	<input type="radio"/>

SCALER	
Woodpecker	<input type="radio"/>

POLYMERIZATION LIGHT	
Mectron Starlight	<input type="radio"/>
Monitex curing light	<input type="radio"/>

INTRAORAL CAMERA	
	<input type="radio"/>

Monitor	
Neovo monitor 22" DR22 white	<input type="radio"/>
Neovo monitor 22" RX22G black	<input type="radio"/>

Disinfection systems	
Semi-automatic disinfection of instruments with Alpron (0,6l additional bottle, 1L Alpron, instruments adapter to be fitted into spittoon bowl)	<input type="radio"/>
Automatic and continuous disinfection of cup filler and instruments hoses (includes extra bottle for disinfection agent)	<input type="radio"/>

Dry suction system	
Venturi system	<input type="radio"/>
Cattani miniseparator	<input type="radio"/>
Dürr CS1 separator	<input type="radio"/>
METASYS ECO-L1, separator water-air	<input type="radio"/>
METASYS1 amalgam separator (including sample disinfection set + applicator + replacement container) separation rate 98,6%	<input type="radio"/>
Dürr CAS-1 amalgam separator (including replacement container) separation rate 97,9%	<input type="radio"/>

Wet suction system	
Standard wet suction	<input type="radio"/>
Extra charge for selection valve (for dental offices with two or more dental chairs)	<input type="radio"/>
Extra charge for selection valve & Dürr Cuspidor valve for wet suction (drain and suction air go to suction machine)	<input type="radio"/>

Options for central water supply	
Central water supply (including 2.5 bar water regulation) + depressurization bottle system	<input type="radio"/>
Funnel for comfort bottle access for central water supply	<input type="radio"/>

Options without central water supply	
2.5 bar water regulation (needed when water inlet pressure is too high)	<input type="radio"/>
Depressurization bottle system	<input type="radio"/>
Funnel for comfort bottle access for unit without central water supply	<input type="radio"/>

Water unit options	
Distilled water bottle	<input checked="" type="radio"/>
Front panel for external media connections (air, water, power ) including 2.5 bar water regulation	<input type="radio"/>

Suction hose regulation	
Only BIG (HVE) Suction with manual regulation	<input type="radio"/>
Only Saliva Ejector	<input type="radio"/>
BIG (HVE) and SMALL Suction with manual regulation - one wet suction filter	<input type="radio"/>
BIG (HVE) and SMALL Suction with Automatic suction control & Multi-station Valve (two suction filters)	<input type="radio"/>

Stools	
D10L with back-rest for the dentist	<input type="radio"/>
D10L with back-rest for sister	<input type="radio"/>
D10L horse-seat	<input type="radio"/>
D10L for microscope	<input type="radio"/>
IRIS with Classic Backrest	<input type="radio"/>
IRIS with Classic Backrest + "Banana" support arm	<input type="radio"/>

Warranty	
Standard two-year warranty period	<input checked="" type="radio"/>
Extra one-year warranty period	<input type="radio"/>
Extra two-year warranty	<input type="radio"/>
Extra three-year warranty	<input type="radio"/>

# Discover the Diplomat Dental portfolio.

Check out our Model Pro Series to find out more about the new era of digitized dentistry.

# Discover the Diplomat Dental portfolio.



Model Pro 500.



Model Pro 600.



Model Pro 700.



Model Pro 800.

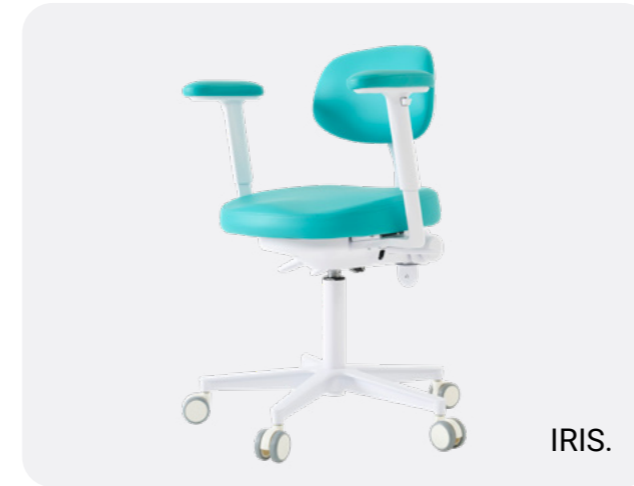

IRIS.

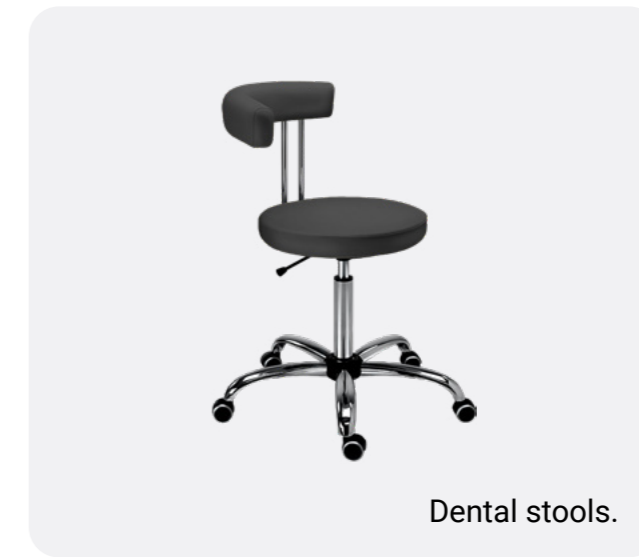

Dental stools.



Cart.

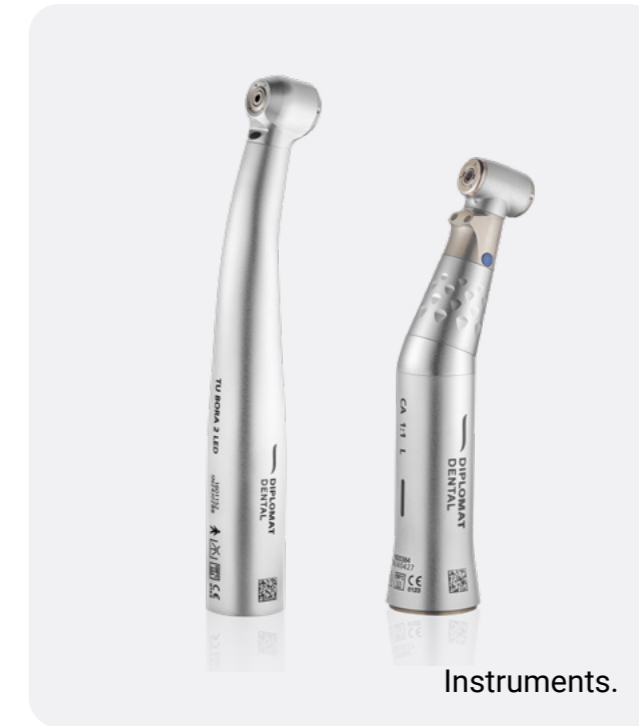

Instruments.

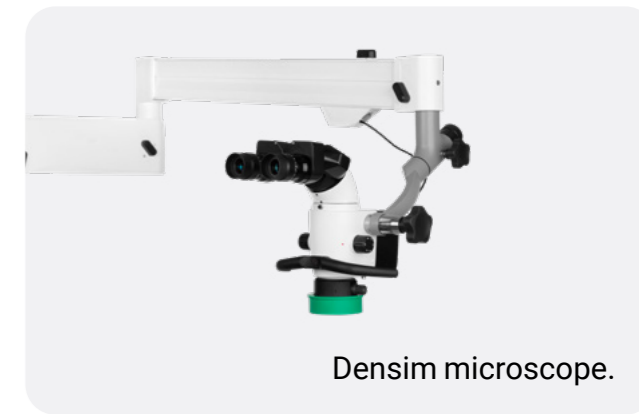

Densim microscope.

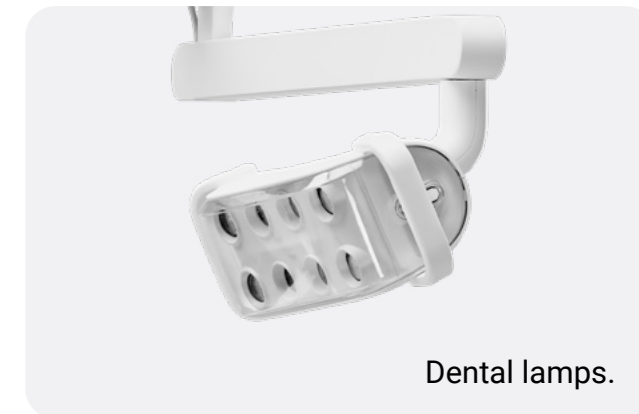

Dental lamps.







Compressors.



**Contact our sales team:**

+421 33 7954 111  
info@diplomat-dental.com

**Follow us:**

 @diplomat\_dental  
 Diplomat dental  
 Diplomat Dental Solutions  
 Diplomat Dental Solutions

**Showroom address:**

DIPLOMAT DENTAL s.r.o.  
Vrbovská cesta 17  
921 01 Piešťany  
Slovak Republic

